

Pulse-40

Inertial Measurement Unit



6 DOF IMU
TACTICAL GRADE
0.8°/h | 6μg



Excellent Performance in Harsh Conditions in the Smallest Package



No Export
Restriction



2-year
Warranty



STABILIZATION

- » High bandwidth (500Hz)
- » High data rate (2KHz)
- » < 2ms motion to output latency
- » Ultra low noise gyro (0.08°/√h)
- » Best in class Vibration Error (VRE)
- » Calibrated from -40 to 85°C

Stabilize your system with high quality, reliable miniaturized IMU

Pulse-40 is perfect for high frequency dynamics and highly vibrating environments. Its very low noise decreases impact over the control system. Our production processes and calibration ensures consistency and repeatable behavior.



NAVIGATION

- » Reliable in all conditions
- » Continuous Built-in-test (CBIT)
- » External clock synchronization
- » Excellent bias instability (0.8°/h)
- » Shocks and vibrations qualified to MIL-STD 810G

Enhance your navigation system accuracy and resilience with tactical grade miniature IMU

Pulse-40 brings your navigation system to the tactical grade. Performance is guaranteed in all weathers and in high vibration conditions. Make your system more reliable and save weight, power, and budget for your core business.

HIGH-END MEMS

Selection of the most reliable accelerometers & gyroscopes able to cope with SBG Systems' high quality requirements.



ROBUST ENCLOSURE

Aluminum enclosure ensures optimal performance in shocks or vibrating conditions, and maintains sensor alignment over time.



-40°C to 85°C

AUTOMATED CALIBRATION



2 axis table

Accelerometers & gyroscopes compensation

- » Bias and scale factor over full temperature range
- » Non-linearity
- » Cross-axis and misalignments effect

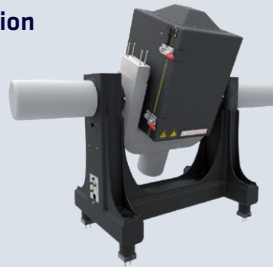

Benefits

- » Maximized IMU performance
- » Minimized human error risks
- » Highly scalable & repeatable process

SCREENING PROCESS

2 axis table

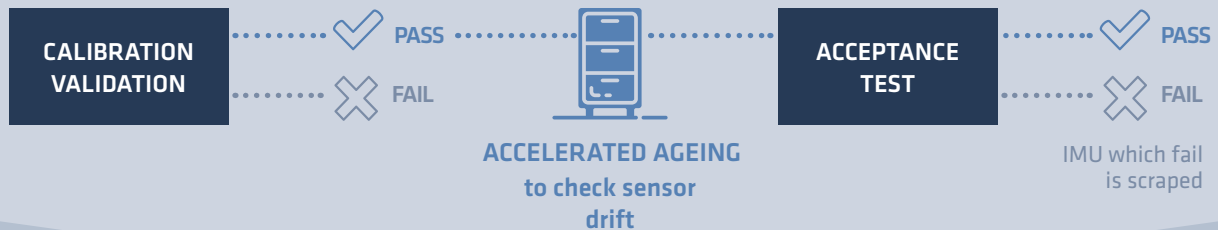

DELIVERING HIGH QUALITY IMU with its own digital calibration report

Calibration report available online with no extra fee!
2 years warranty in standard.

- ✓ Quality & Consistency
- ✓ Leaflet Performance Guaranteed
- ✓ Reliability in all Conditions



THIS IS HOW WE BUILD TRUST

1-sigma errors over full temperature range [-40 to 85°C]

GYROSCOPES & ACCELEROMETERS

Parameter	Gyroscope	Accelerometer
Measurement range	$\pm 490^\circ/\text{s}$, $\pm 2000^\circ/\text{s}$ ⁽⁴⁾	$\pm 40 \text{ g}$
Scale factor error ⁽¹⁾	1,000 ppm	300 ppm
Non-linearity error ⁽¹⁾	50 ppm of FS	50 ppm of FS
Random walk ⁽²⁾	$0.08^\circ/\sqrt{\text{h}}$	$35 \mu\text{g}/\sqrt{\text{h}}$
Bias instability ⁽³⁾	$0.8^\circ/\text{h}$	$6 \mu\text{g}$
One-year bias repeatability ⁽¹⁾	$250^\circ/\text{h}$	1500 mg
Orthogonality	0.02°	0.01°
Bandwidth	480 Hz	480 Hz
Vibration Rectification Error (VRE)	$0.2^\circ/\text{h/g}^2$	0.03 mg/g^2

⁽¹⁾ Error measured over a one year accelerated ageing process.

⁽²⁾ Allan variance method.

⁽³⁾ Bias > 1,250 mg to comply with export regulation.

⁽⁴⁾ 2000°/s version is export controlled. Contact us for more information.

MECHANICAL & ENVIRONMENTAL

Mechanical dimensions	30 × 28 × 13.3 mm
Weight	12 g
Operating Temperature range	-40 to 85°C
Non operating Temperature range	-40 to 85°C
EMC	EN 55032:2015, EN 61000-4-3, EN 61000-6-1, EN 55024
Operating Vibrations	10 g RMS [20 - 2 kHz] MIL-STD-810G
MTBF (computed)	50,000 hours

ELECTRICAL

Input Voltage	[3.3 ; 5.1] V
Power consumption	Typical @5V 0.3W

COMMUNICATION

Output baud rate	Up to 4M bps
Output data rate	Up to 2kHz
Digital serial Interface	UART (LVTTTL)

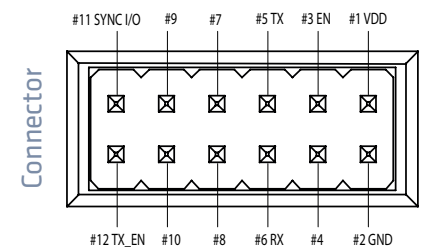
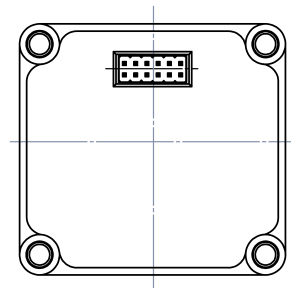
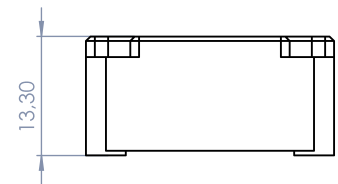
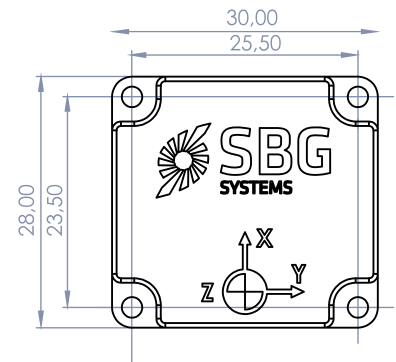
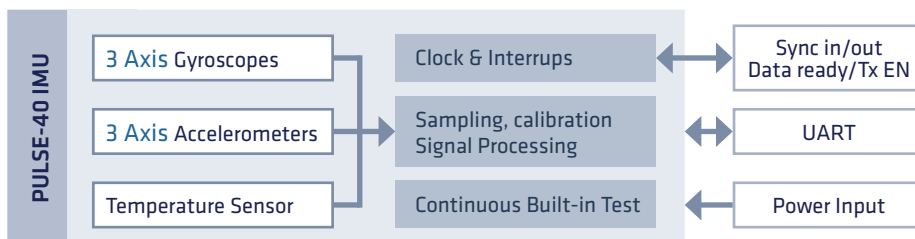

All values are in mm.

SENSORS SPECIFICATION - ALLAN VARIANCE

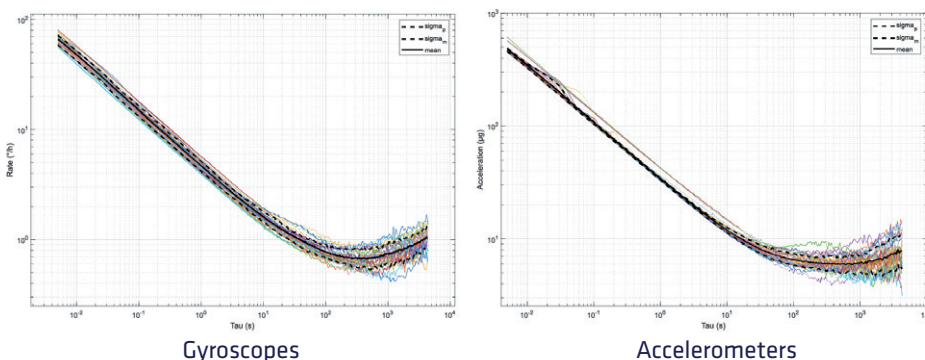

Preliminary version. All specifications subject to change without notice.

Easy to evaluate

The Pulse-40 Starter Kit contains all accessories to start working in minutes!



SBG Systems is a leading supplier of inertial motion sensing solutions since 2007. The company provides a wide range of inertial solutions from miniature to high accuracy. Combined with cutting-edge calibration techniques and advanced embedded algorithms, SBG Systems products are ideal solutions for industrial & research projects such as unmanned vehicle control, surveying applications, antenna tracking, and camera stabilization. **Committed to highest quality standards, SBG Systems is an ISO 9001:2015 certified company.**



SBG Systems EMEA (Headquarters)

Phone: +33 1 80 88 45 00

E-mail: sales@sbg-systems.com

SBG Systems North America

Phone: +1 (657) 845 1771

E-mail: sales.usa@sbg-systems.com

SBG Systems Singapore

Phone: +65 3158 5783

E-mail: sales.asia@sbg-systems.com

www.sbg-systems.com