



Trimble GA810 Antenna

PRECISION GNSS ANTENNA FOR MARINE APPLICATIONS

The Trimble GA810 GNSS antenna is designed to support high precision marine applications. It is equipped with 100% humidity proof enclosure and threaded mounting to protect from harsh environments commonly seen in marine applications.

COMPREHENSIVE GNSS SUPPORT

The Trimble GA810 antenna offers full support for current and near-future GNSS signals from GPS, GLONASS, Galileo, BeiDou, QZSS, IRNSS, OmniSTAR, Trimble RTX and SBAS.

Key Features of Trimble GA810:

- ▶ Equipped with a mag switch to allow users to change between MSS wideband and narrowband
- ▶ Thread mount prevents rusting caused by salt and water in marine applications

Key Features

- ▶ Comprehensive GNSS support, including GPS modernization signals, GLONASS, BeiDou, Galileo, QZSS and IRNSS
- ▶ OmniSTAR and RTX Support
- ▶ Supports MSS narrowband and wideband
- ▶ Rugged and 100% humidity proof



Trimble GA810 GNSS Antenna

TECHNICAL SPECIFICATIONS

Comprehensive GNSS Tracking:

- GPS: L1, L2, L5
- GLONASS: L1, L2, L5
- Galileo: E1, E5a, E5b, E6
- BeiDou: B1, B2, B3
- QZSS: L1, L2, L5, L6, LEX
- IRNSS: L5
- SBAS: WAAS, EGNOS, GAGAN, and MSAS
- MSS: OmniSTAR, Trimble RTX

Magnetic switch for narrowband and wideband

- Wideband mode: 1525 - 1614 MHz
- Narrowband mode: 1555 - 1608 MHz

MTBF >150,000 hours

Compliance CE compliant including ISO 7637, 2011/65/EU (RED), EN 55022, E-Mark and RoHS, FCC, ICES and RSS compliant

PHYSICAL AND ELECTRICAL SPECIFICATIONS

Dimensions 16.13 cm diameter x 7.44 cm height (6.35 in diameter x 2.93 in height)

Weight 0.57 Kg (1.26 lb)

Input Voltage 3.4 VDC to 12 VDC

Input Current <130 mA

Signal Gain 48 dB

Signal Connector TNC Female

Mounting 5/8" - 11 Female Thread

ENVIRONMENTAL QUALIFICATIONS

Operating Temperature. . . -40 °C to +70 °C (-40 °F to +158 °F)

Humidity 100% humidity proof, fully sealed, IP67

Shock and Vibration

Tested and meets the following environmental standards:

Shock MIL-STD-810-F to survive a 2 m (6.56 ft) drop onto concrete

Vibration MIL-STD-810-F on each axis

PART NUMBER

99810-30-INT Trimble GA810 Antenna

Specifications subject to change without notice.

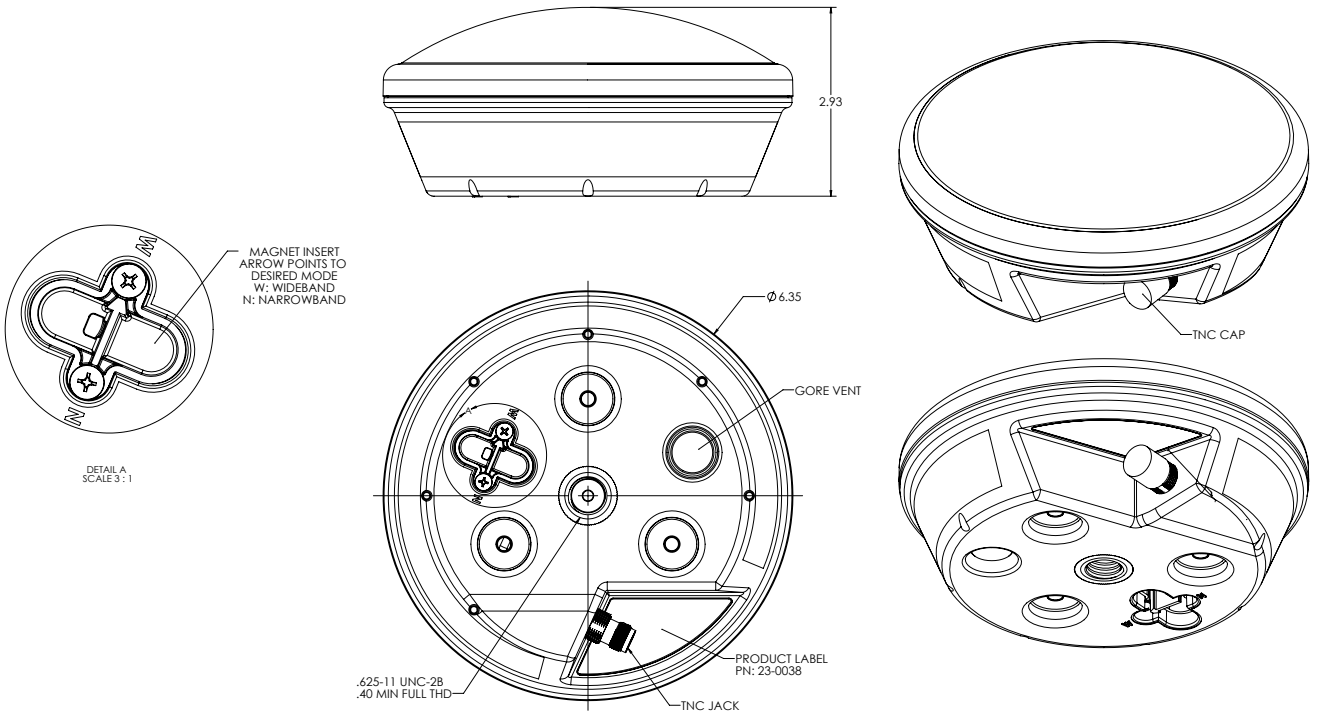

Contact your local dealer today

TRIMBLE
 Integrated Technologies
 510 DeGuigne Drive
 Sunnyvale, CA 94085
 Americas & Asia-Pacific
 Europe/EMEA

Email: sales-intech@trimble.com

© 2020, Trimble Navigation Limited. All rights reserved. Trimble logo are trademarks of Trimble, registered in the United States and in other countries. All other trademarks are the property of their respective owners. (02/20)